

IL494A

PWM Control Circuit

The IL494 incorporates on a single monolithic chip all the functions required in the construction of a pulse-width-modulation control circuit. Designed primarily for power supply control, the IL494 contains an on-chip 5-volt regulator, two error amplifiers, adjustable oscillator, dead-time control comparator, pulse-steering flip-flop, and output-control circuitry. The uncommitted output transistors provide either common-emitter or emitter-follower output capability. Push-pull or single-ended output operation may be selected through the output-control function. The architecture of the IL494 prohibits the possibility of either output being pulsed twice during push-pull operation.

- Complete PWM Power Control Circuitry
- Uncommitted Outputs for 200 mA Sink or Source
- Output Control Selects Single-Ended or Push-Pull Operation
- Internal Circuitry Prohibits Double Pulse at Either Output
- Internal Regulator Provides a Stable 5 V Reference Supply
- Variable Dead-Time Provides Control Over Total Range

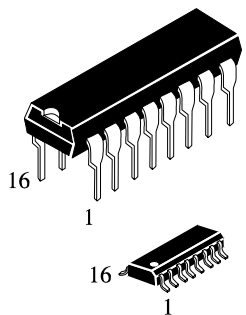

N SUFFIX
PLASTIC

D SUFFIX
SOIC

ORDERING INFORMATION
IL494N Plastic
IL494D SOIC
T_A = -20°C to 85°C for all packages

FUNCTION TABLE

| Output Control | Output Function |
|---------------------|---------------------------------|
| Grounded | Single-ended or Parallel Output |
| At V _{ref} | Normal Push-Pull Operation |

PIN ASSIGNMENT

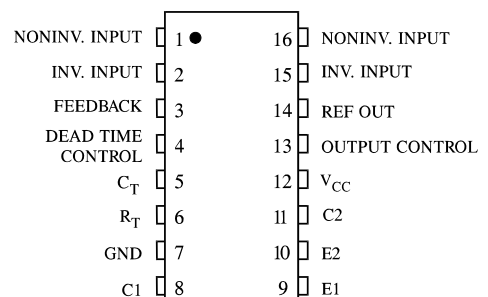

LOGIC DIAGRAM

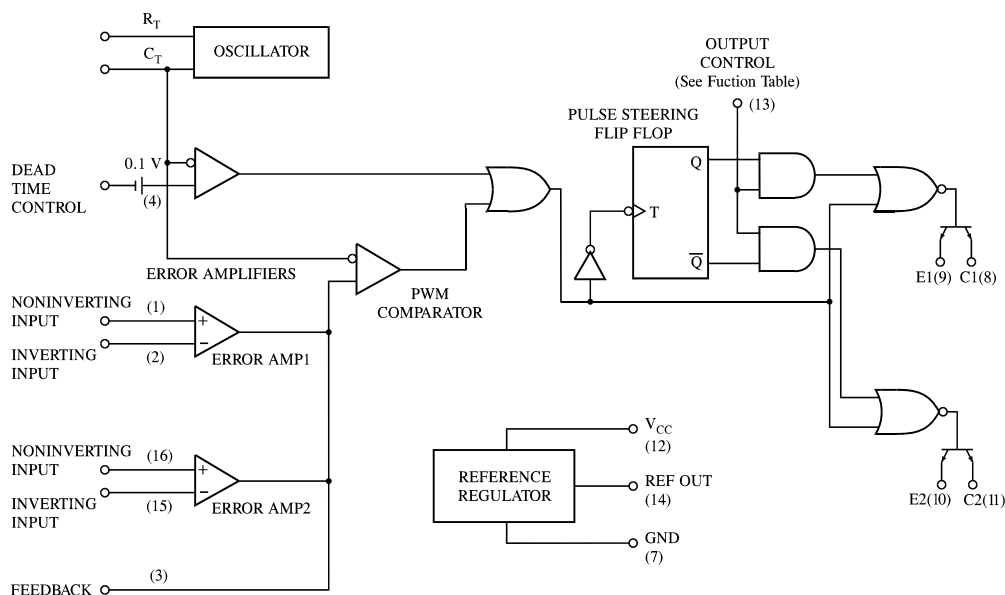

MAXIMUM RATINGS

| Symbol | Parameter | Value | Unit |
|------------------|--------------------------|----------------------|------|
| V _{CC} | Supply Voltage | 41 | V |
| V _I | Amplifier Input Voltage | V _{CC} +0.3 | V |
| V _O | Collector Output Voltage | 41 | V |
| | Collector Output Current | 250 | mA |
| T _{stg} | Storage Temperature | -65 to +150 | °C |

RECOMMENDED OPERATING CONDITIONS

| Symbol | Parameter | Min | Max | Unit |
|-----------------|--|------|---------------------|------|
| V _{CC} | Supply Voltage | 7 | 40 | V |
| V _I | Amplifier Input Voltage | -0.3 | V _{CC} - 2 | V |
| V _O | Collector Output Voltage | | 40 | V |
| | Collector Output Current (Each Transistor) | | 200 | mA |
| | Current Into Feed back Terminal | | 0.3 | mA |
| C _T | Timing Capacitor | 0.47 | 10.000 | nF |
| R _T | Timing Resistor | 1.8 | 500 | KΩ |
| | Oscillator Frequency | 1 | 300 | KHz |
| T _A | Operating Free-Air Temperature | -20 | +85 | °C |

ELECTRICAL CHARACTERISTICS (Temperature -20 ~ 85°C, V_{CC} = 15 V, f=10 kHz)

| Symbol | Parameter | Test Conditions | Min | Max | Unit |
|----------------------------------|--|---|------|---------------------|------|
| Reference Section | | | | | |
| V _{ref} | Output Voltage | I _O =1 mA | 4.95 | 5.05 | V |
| V _{regin} | Output regulation | V _{CC} =7 V to 40 V, T _A =25°C | | 25 | mV |
| V _{regout} | Input regulation | I _O =1 to 10 mA, T _A =25°C | | 15 | mV |
| ΔV _{ref} | Output Voltage change with temperature | T _A = -20°C to 85°C | | 1 | % |
| I _{SC} | Short-circuit output current (Note 1) | V _{ref} =0 | | 50 | mA |
| Oscillator Section | | | | | |
| f _{OSC} | Frequency | C _T =0.01 μF, R _T =12 kΩ | 6 | 14 | KHz |
| δf _{OSC} | Standard deviation of frequency (Note 2) | All values of V _{CC} , C _T , R _T , T _A Constant | | 15 | % |
| δf _{OSC(ΔV)} | Frequency change with voltage | V _{CC} = 7 V to 40 V, T _A =25°C | | 10 | % |
| δf _{OSC(ΔT)} | Frequency change with temperature | C _T =0.01 μF, R _T =12 kΩ T _A = -20°C to 85°C | | 2 | % |
| Dead Time Control Section | | | | | |
| I _{IB(2T)} | Input bias current (pin 4) | V _I = 0 to 5.25 V | | -10 | μA |
| DC _{max} | Maximum duty cycle, each output | V _{I(pin 4)} =0 V | 45 | | % |
| V _{THD} | Input threshold voltage (pin 4) | Zero duty cycle | | 3.3 | V |
| | | Maximum duty cycle | 0 | | |
| Error Amp Section | | | | | |
| V _{IO} | Input offset voltage | V _{O(pin 3)} =2.5 V | | 10 | mV |
| I _{IO} | Input offset current | V _{O(pin 3)} =2.5 V | | 250 | nA |
| I _{IB} | Input bias current | V _{O(pin 3)} =2.5 V | | 1 | μA |
| | Common-mode input voltage range | V _{CC} = 7 V to 40 V | LOW | -0.3 | V |
| | | | HIGH | V _{CC} - 2 | |
| A _{vol} | Open-loop voltage amplification | ΔV _O =3 V, V _O =0.5 to 3.5 V | 70 | | dB |
| f _b | Unity-gain bandwidth | | 100 | | kHz |
| CMRR | Common-mode rejection ratio | V _{CC} =40 V, T _A =25°C | 65 | | dB |
| I _O | Output sink current (pin 3) | V _{ID} =-15 mV to -5 V, V _{O(pin 3)} =0.7 V | 0.3 | | mA |
| I _{O+} | Output source current (pin 3) | V _{ID} =15 mV to 5 V, V _{O(pin 3)} =3.5 V | -2 | | mA |

ELECTRICAL CHARACTERISTICS (Temperature -20 ~ 85°C, V_{CC} = 15 V, f=10 kHz)

| Symbol | Parameter | | Test Conditions | Min | Max | Unit |
|----------------------------------|---------------------------------|------------------|--|-----------------------|------|------|
| PWM Comparator Section | | | | | | |
| V _{THP} | Input threshold voltage (pin 3) | | Zero duty cycle | | 4.5 | V |
| I _I | Input sink current (pin 3) | | V _{O(pin 3)} =0.7 V | 0.3 | | mA |
| Switching Characteristics | | | | | | |
| t _{rc} | Output voltage rise time | | Common-emitter configuration | | 200 | ns |
| t _{fc} | Output voltage fall time | | Common-emitter configuration | | 100 | ns |
| t _{rf} | Output voltage rise time | | Emitter-follower configuration | | 200 | ns |
| t _{ff} | Output voltage fall time | | Emitter-follower configuration | | 100 | ns |
| Output Section | | | | | | |
| I _{C(off)} | Collector off-state current | | V _{CE} =40 V, V _{CC} =40 V | | 100 | μA |
| I _{E(off)} | Emitter off-state current | | V _{CC} =V _C =40 V, V _E =0 | | -100 | μA |
| V _{SAT} | Collector-emitter | Common-emitter | V _E =0, I _C =200 mA | | 1.3 | V |
| | saturation voltage | Emitter-follower | V _C =15 V, I _E =-200 mA | | 2.5 | |
| I _{OCH} | Output control input current | | V _I =V _{ref} | | 3.5 | mA |
| Total Device | | | | | | |
| I _{CC} | Standby supply current | | All other inputs & outputs open | V _{CC} =15 V | 10 | mA |
| | | | | V _{CC} =40 V | 15 | |
| I _{CCA} | Average supply current | | V _(pin 4) =2 V | | 17 | mA |

- Notes:** 1. Duration of the short circuit should not exceed one second.
 2. Standard deviation is a measure of the statistical distribution about the mean as derived from the formula

$$\sigma = \sqrt{\frac{\sum_{n=1}^N (x_n - \bar{x})^2}{N - 1}}$$

**N SUFFIX PLASTIC DIP
(MS - 001BB)**

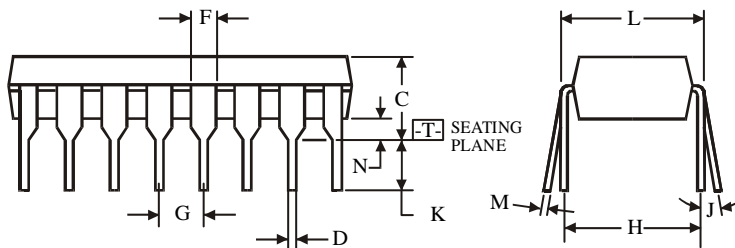
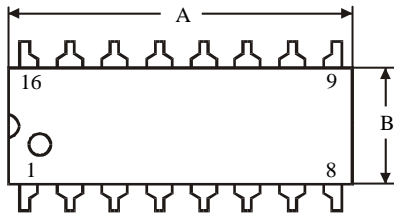
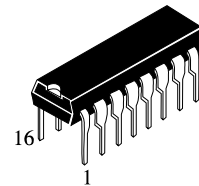

$\oplus 0.25 (0.010) \text{ (M) } T$

NOTES:

- Dimensions "A", "B" do not include mold flash or protrusions.
Maximum mold flash or protrusions 0.25 mm (0.010) per side.

| Symbol | Dimension, mm | |
|--------|---------------|-------|
| | MIN | MAX |
| A | 18.67 | 19.69 |
| B | 6.1 | 7.11 |
| C | | 5.33 |
| D | 0.36 | 0.56 |
| F | 1.14 | 1.78 |
| G | 2.54 | |
| H | 7.62 | |
| J | 0° | 10° |
| K | 2.92 | 3.81 |
| L | 7.62 | 8.26 |
| M | 0.2 | 0.36 |
| N | 0.38 | |

**D SUFFIX SOIC
(MS - 012AC)**

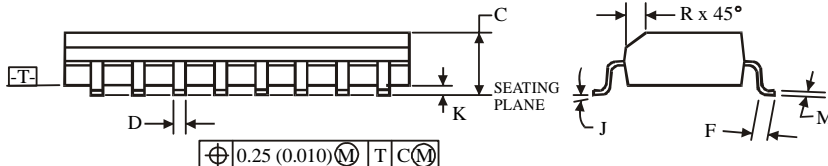
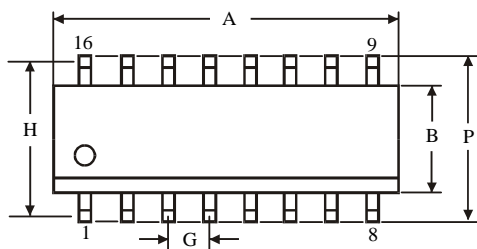
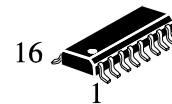

$\oplus 0.25 (0.010) \text{ (M) } T \text{ C (M)}$

NOTES:

- Dimensions A and B do not include mold flash or protrusion.
- Maximum mold flash or protrusion 0.15 mm (0.006) per side for A; for B - 0.25 mm (0.010) per side.

| Symbol | Dimension, mm | |
|--------|---------------|------|
| | MIN | MAX |
| A | 9.8 | 10 |
| B | 3.8 | 4 |
| C | 1.35 | 1.75 |
| D | 0.33 | 0.51 |
| F | 0.4 | 1.27 |
| G | 1.27 | |
| H | 5.72 | |
| J | 0° | 8° |
| K | 0.1 | 0.25 |
| M | 0.19 | 0.25 |
| P | 5.8 | 6.2 |
| R | 0.25 | 0.5 |